

22KW EV ON-BOARD CHARGER

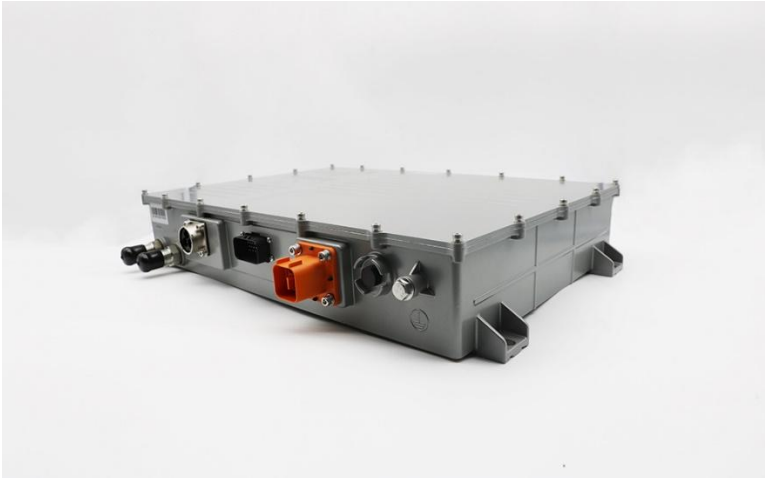

Features

- Universal AC input range
- Input/output protections
- Intelligent charging modes
- Customized CAN communication optional
- 250/500kbs communication rate optional
- UDS boot loader and diagnostic optional
- IP67 enclosure, liquid cooled

Main Specifications

Part Number		Input Voltage	Output Voltage	Output Current	Ripple & Noise (mVp-p)
CAD222DF-700A	OBC	152-456Vac 90-265Vac	400-850Vdc	0-24A (3 phase) 0-10A (1 phase)	≤±4%

Electrical Specifications

These specifications are valid over the converter's full ranges of input voltage output voltage and current, and operating temperature unless noted otherwise.

AC Input Specifications

Input Voltage single phase	90-265VAC
Input Voltage three phase	152-456VAC
Max input current three phase	34A
Max input current single phase	32A
Power Factor	0.99

DC Output Specifications

HV Output Voltage single phase	400-850VDC
HV Output Voltage three phase	400-850VDC
LV Output	14VDC 5A
Max charging current three phase	24A
Max charging current single phase	10A
Max charging power three phase	22KW
Max charging power single phase	6.6KW
Efficiency	95%

Mechanical Data/Cooling System

Housing material	Aluminum
Weight	25kg
Housing volume	12L
IP protection rate	IP 6K9K
Cooling	Liquid-cooled

Safety

Input over voltage protection	Yes
Input under voltage protection	Yes
Output over voltage protection	Yes
Output under voltage protection	Yes
Output over current protection	Yes
Output short circuit protection	Yes

Input Connector Description

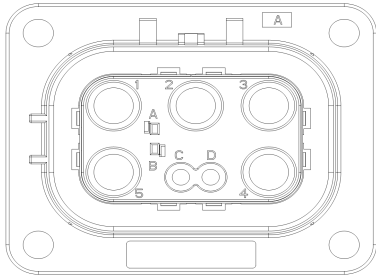
PIN NO.	Name	Model: BHL10-E401X-S6	Mating Connector: BHL18-E40X1-S6
		Supplier: BALE	
1	L1		
2	L2		
3	L3		
4	N		
5	PE		

High Voltage Output Connector Description

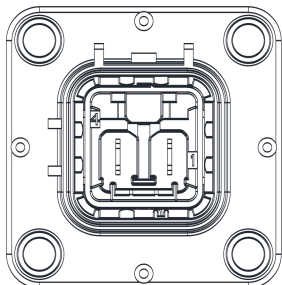
PIN NO.	Name	Model: 1-2141272-1	Mating Connector: 5-1418758-3
		Supplier: TE	
1	Out +		
2	Out -		
3	HVIL		
4	HVIL		

Signal Connector Description

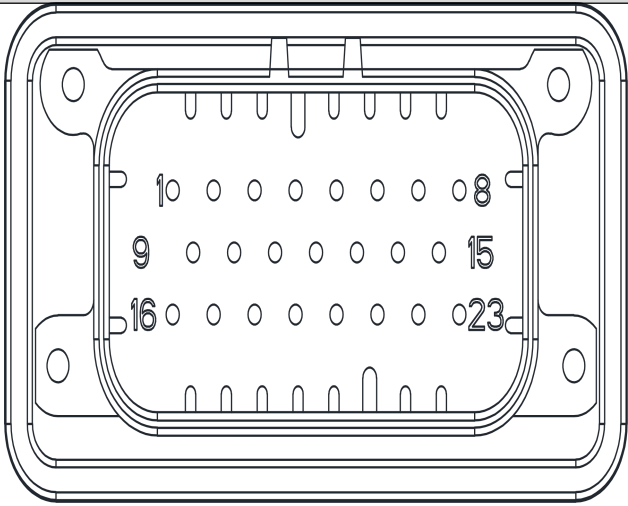
PIN NO.	Name	Model: 1-776228-1	Mating Connector: 1-770520-1
		Supplier: TE	
4	KL15		
5	CP		
6	PP		
7	KL30		
9	BMS wake-up signal		
10	LED		
11	HVIL 1		
12	HVIL 2		
13-15	GND (KL31)		
19	CAN GND		
20, 22	CAN L		
21, 23	CAN H		
Others	N/A		

Mechanical Parameters (unit: mm)

